

Programmable Magnetic Flowmeter User Manual

FM100 Series

Table of Contents

Introduction	iii
Warranty and Warranty Restrictions	iv
Chapter 1: Specifications and Options.....	1
Dimensions	1
Specifications	2
Flow Rates per Line Size	2
Model Number Configurator.....	3
Wiring Diagram and Terminal Layout	4
Chapter 2: Installation and Removal Procedures and Notes.....	5
Tools Needed.....	5
Installation Requirements and Recommendations.....	5-7
Electrical Installation	7
Grounding Instructions	8
Removal Instructions	8
Chapter 3: Set Up and Operation	9
User Interface	9
FM100 Display Mode Menu	10
FM100 Setup Menus.....	10-13
Enter/Change Password	14
Display Mode Menus.....	15-16
Onboard Archives	16
Production Data Setup Menu	17
Sensor Setup Menu	18-19
Analog Output Setup Menu	19-20
Display Setup Menu	20-22
Exit Menu	22
Chapter 4: Error Messages.....	23
Error Codes and Explanations.....	23-24
Chapter 5: Maintenance	25
General Care	25
Troubleshooting	25
Repair and Returns.....	25

Introduction

Thank you for purchasing an FM100 programmable magnetic flowmeter from APG. We appreciate your business! Please take a few minutes to familiarize yourself with your FM100 and this manual.

The FM100 Programmable Magnetic Flowmeter is a highly accurate, bi-directional flowmeter, with configurable 4-20 mA output. It comes with a two-line LCD display and four-button keypad for intuitive display set up and menu navigation. The hard technical rubber liner of the FM100 is compatible with most water and waste water applications.

Reading your label

Every APG FM100 comes with a two labels, one on the sensor and one on the converter. The converter label will include the APG model number (starting with FM100-) and serial number, while the sensor will have the sensor number. Please ensure that the model number on your converter label matches your order.

Warranty and Warranty Restrictions

This product is covered by APG's warranty to be free from defects in material and workmanship under normal use and service of the product for 24 months. For a full explanation of our Warranty, please visit <https://www.apgsensors.com/about-us/terms-conditions>. Contact Technical Support to receive a Return Material Authorization before shipping your product back.

Scan the QR code below to read the full explanation of our Warranty on your tablet or smartphone.



Chapter 1: Specifications and Options

- **Dimensions**

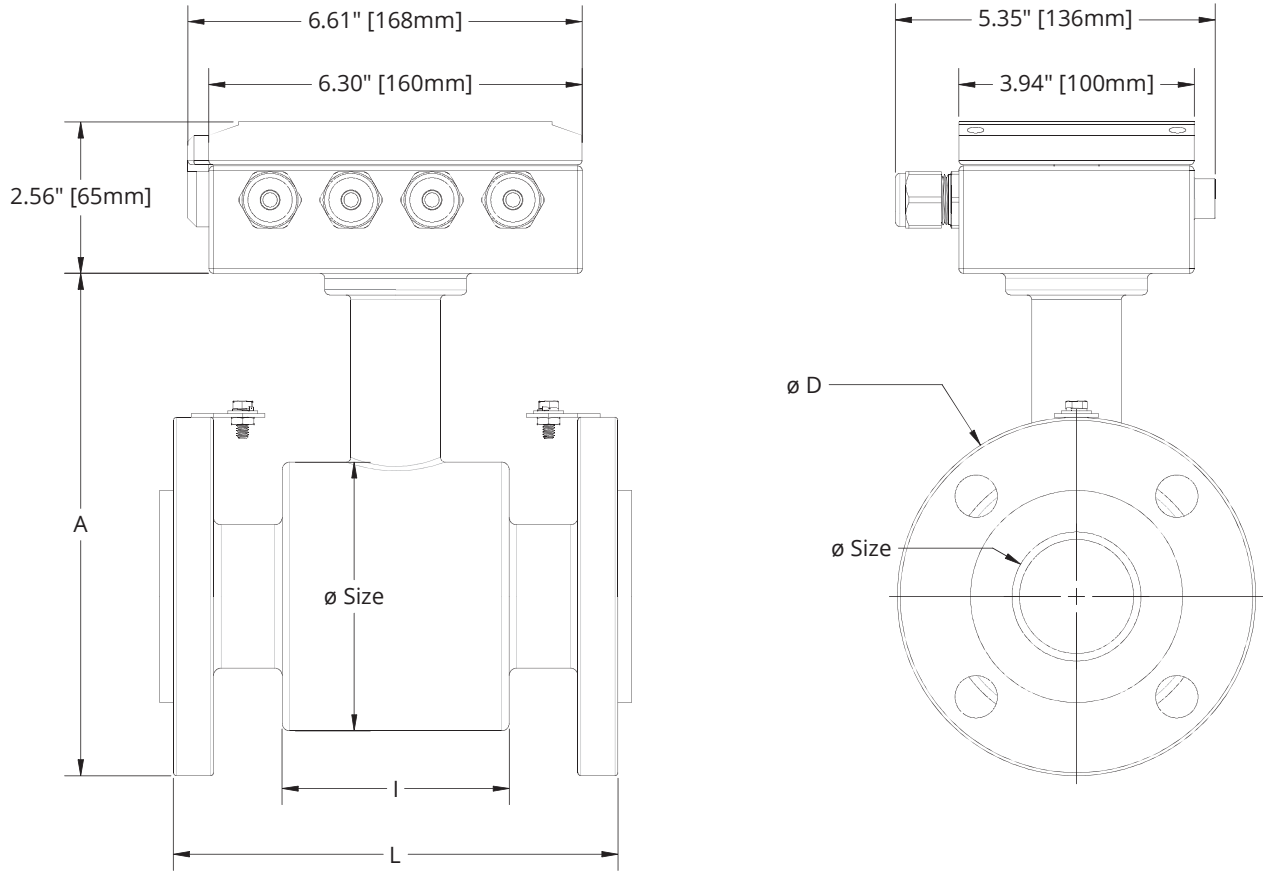

Size	Flange	$\varnothing D^*$	L**	A	Weight
1" (25mm)	150lbs	4.53" (115mm)	7.87" (200mm)	7.09" (180mm)	9.7 lbs (4.4 kg)
2" (50mm)	150lbs	6.30" (160mm)	7.87" (200mm)	8.78" (223mm)	19.6 lbs (8.9 kb)
3" (80mm)	150lbs	7.68" (195mm)	7.87" (200mm)	10.2" (260mm)	28.4 lbs (12.9 kg)
4" (100mm)	150lbs	8.46" (215mm)	9.84" (250mm)	11.0" (280mm)	37.2 lbs (16.9 kg)
6" (150mm)	150lbs	11.0" (280mm)	11.8" (300mm)	13.4" (340mm)	63.6 lbs (28.9 kg)

*Flange dimensions meet ANSI B 16.5

**Standard construction length meets ISO 13359.

- **Specifications**

Accuracy

Accuracy <0.5% of full scale
Resolution 16 bit resolution DAC

Environmental

Process Temperature 32 - 158 °F (0.1- 70 °C)
Enclosure Protection IP67

Electrical

Supply Voltage 85 - 265 VAC
4-20 mA Loop Resistance 1000Ω
Minimum Fluid Conductivity 20μS/cm

Materials of Construction

Measuring Tube Stainless Steel
Flanges, Housing Carbon Steel, Polyurethane paint
Converter Box Aluminum, Powder paint
Sensor Lining Hard Technical Rubber
Electrodes AISI 316Ti Stainless Steel

- **Flow Rates per Line size**

Size		Flow Rates				R25 Range (Q ₃)	
Inches	mm	Q _{min}		Q _{max}		(Q ₃ @ Q ₃ /Q ₁ =25)	
1"	25	0.7740 gpm	2.94 l/m	93.36 gpm	353.4 l/m	27.74 gpm	6.3 m ³ /hr
2"	50	3.114 gpm	11.78 l/m	373.4 gpm	1414 l/m	110.1 gpm	25 m ³ /hr
3"	80	7.968 gpm	30.16 l/m	955.8 gpm	3619 l/m	277.4 gpm	63 m ³ /hr
4"	100	12.45 gpm	47.12 l/m	1494 gpm	5654 l/m	440.3 gpm	100 m ³ /hr
6"	150	28.01 gpm	106.0 l/m	3360 gpm	12.72 x 10 ³ l/m	1101 gpm	250 m ³ /hr

• Model Number Configurator

Model Number: FM100 - - - - - -
 A B C D E F

A. Size (Pipe Diameter)

- 01** 1"
- 02** 2"
- 03** 3"
- 04** 4"
- 06** 6"

B. Process Connection

- F** 150 lb Flange

C. Liner Material

- 1** Hard Rubber

D. Output

- A6** 4-20 mA

E. Input Power

- 1** 85 - 240 VAC

F. Display

- LCD** LCD Display

- **Wiring Diagram and Terminal Layout**

The FM100 comes with an active 4-20 mA output, and requires 85 - 240 VAC input power. The 4-20 mA loop is connected to pins 12 and 13 (See Figures 1.1 and 1.2), and power is connected on the L, N, and PE terminals at the far right (Figure 1.2).

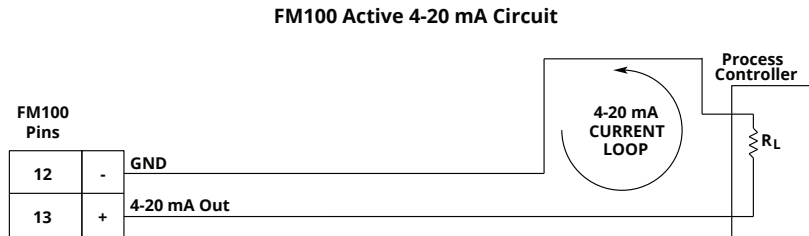

Figure 1.1 - 4-20 mA Wiring Diagram

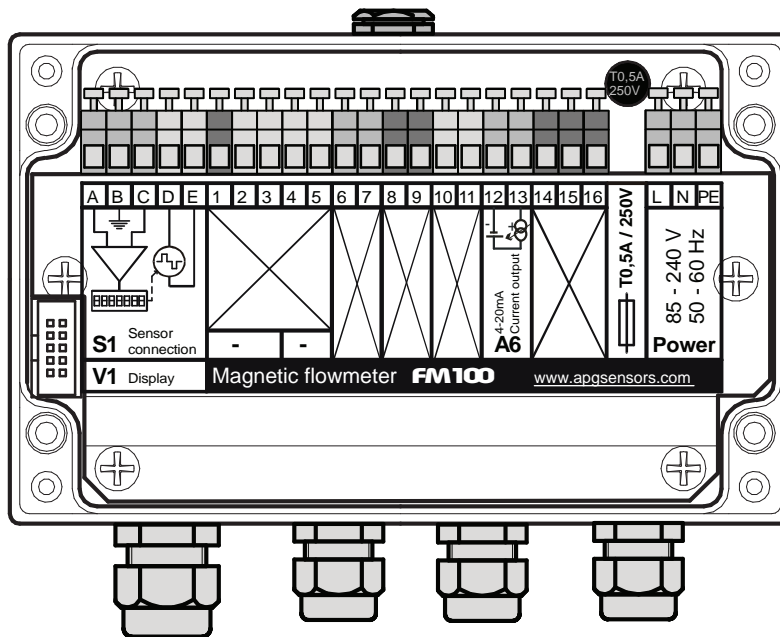

Figure 1.2 - FM100 Terminal Layout

Chapter 2: Installation and Removal Procedures and Notes

• Tools Needed

Two sets of tools will be needed to install your FM100. One set will be necessary to physically install the FM100 in the pipe line. Physical installation of your FM100 in the pipeline should be done by a piping installer, using appropriate tools.

To electrically install your FM100, you will need:

- A small phillips head screwdriver
- A small flat head screwdriver

 **NOTE:** Physical installation of your FM100 in the pipeline should be done by a piping installer, using appropriate tools.

• Installation Requirements and Recommendations

To ensure proper operation of your FM100, the following installation requirements must be met.

1. Pipe adjacent to the FM100 must match the sensor exactly (see Figure 2.1). Any transitions will create turbulence that will disrupt sensor operation.
2. Pipe adjacent to the FM100 must be straight, without fittings or bends) for at least 5 times the diameter of the sensor upstream and 3 times the diameter of the sensor downstream (see Figure 2.2).

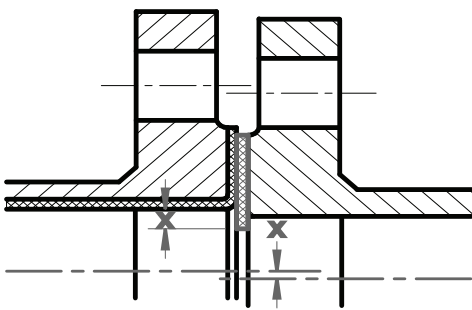

Figure 2.1

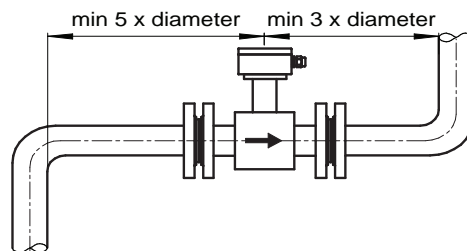

Figure 2.2

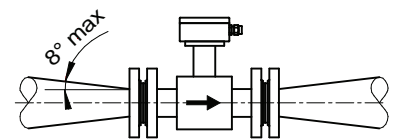

Figure 2.3

 **NOTE:** Straight-line lengths may include up to 8° slopes (see Figure 2.3)

3. The FM100 must be located downstream of any pumps in the pipeline (see Figure 2.4). Straight-line length of at least 25 times the diameter of the sensor is required between a pump and the FM100.
4. Stop valves must be located downstream of the sensor (see Figure 2.5), ensuring that the sensor does not run dry when the valve is closed.
5. If necessary, a bypass can be installed for sensor installation and removal (see Figure 2.6).

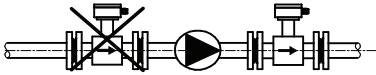

Figure 2.4

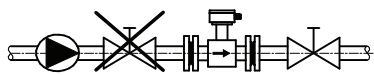

Figure 2.5

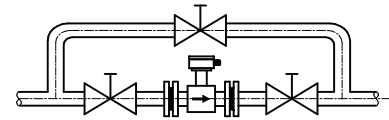

Figure 2.6

For optimal operation of your FM100, the following installation recommendations should be followed.

1. For sensors installed near vertical sections of pipe, the FM100 can be either in the horizontal section upstream of the vertical, or on the upstream vertical (see Figure 2.7). To avoid airlock, it must not be installed on the raised section of pipe, nor on the downstream vertical.
2. Where continuous flow is too low to ensure permanent flooding of the full cross section of the sensor, a low-water trap can be used to create permanent flood in the FM100 (see Figure 2.8).
3. Pipe supports of adjacent pipe should be placed as close to the FM100 as possible to reduce the risk of vibration (see Figure 2.9).
4. For horizontal installation of the FM100, the electrodes must be within 45° of the horizontal plane (see Figure 2.10).

NOTE: For sensors installed on vertical pipe, nominal flow should be upward through the FM100 (see Figure 2.7).

IMPORTANT: Do NOT touch the electrodes inside the FM100 sensor chamber.

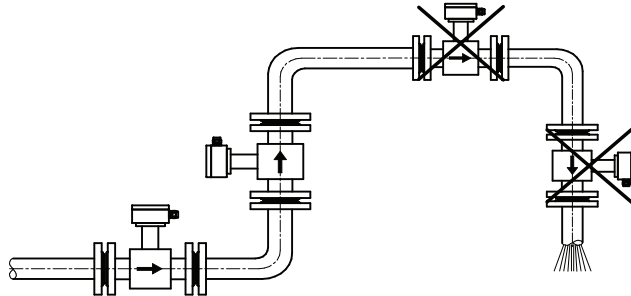

Figure 2.7

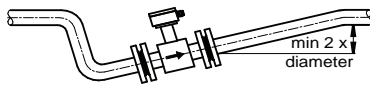

Figure 2.8

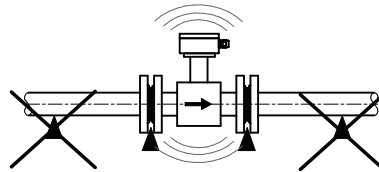

Figure 2.9

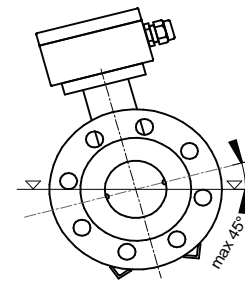

Figure 2.10

• Electrical Installation

- Use the philips head screwdriver to remove the four small screws on the top of the cover, and open the cover (hinged on the left side).
- Insert the incoming power line through the right-most cable gland. Connect the wires to the L, N, and PE terminals (see Figure 1.2). Use the small flat head screwdriver to operate the terminals if necessary.
- Insert the 4-20 mA loop cable through another cable gland. Connect the wires to terminals 12 and 13 (see Figure 1.2). Use the small flat head screwdriver to operate the terminals if necessary.
- Replace the cover and screws.

- **Grounding Instructions**

There are three grounding scenarios for the FM100:

- **For adjacent conductive pipe:**

1. Wire each flange of the FM100 to the adjacent pipe.
2. Ground both sections of the pipeline.

- **For non-conductive adjacent pipe:**

1. Use conductive grounding rings between the flanges to establish a connection from the conducting fluid to ground.
2. Wire each flange of the FM100 to a ground ring.
3. Ground both grounding rings.

- **For electrified fluid (e.g. cathodic protection against corrosion):**

1. Ensure complete electrical isolation of the FM100 from the adjacent pipe.
2. Wire the adjacent upstream pipe to the adjacent downstream pipe, bridging over the FM100.
3. Use galvanized conduit for the electrical connection to the FM100 to ensure isolation.

- **Removal Instructions**

- Ensure that power to the sensor and current loop are both off.
- Ensure that liquid is not flowing through the sensor.
- Disconnect both cables to sensor.
- Remove the sensor and store it in a dry place, at a temperature between -40° F and 180° F.

Chapter 3: Set Up and Operation

- **User Interface**

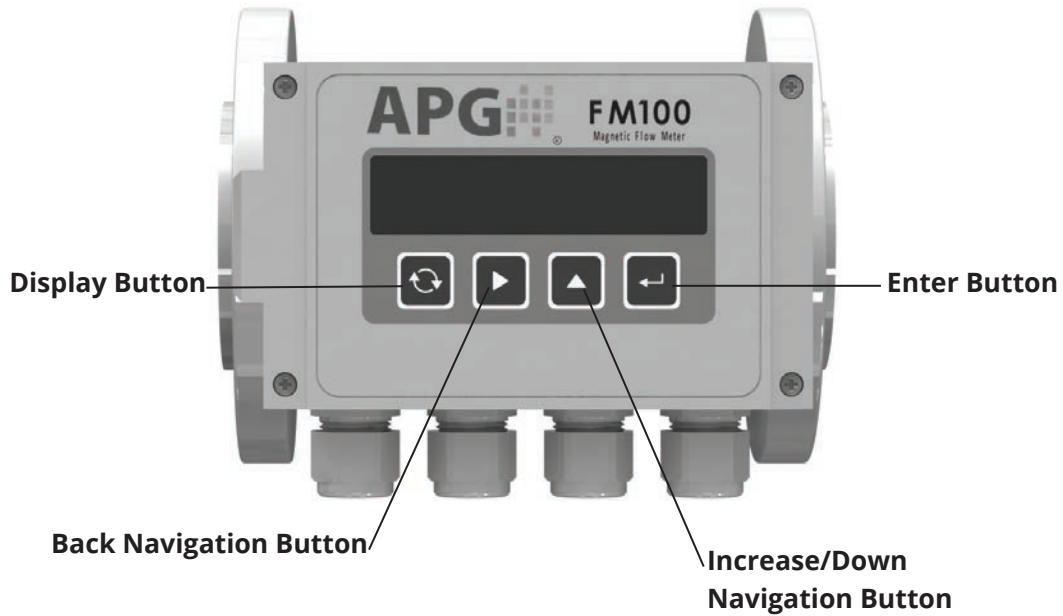

Figure 3.1

The operation of the FM100's three buttons depends on whether the FM100 is in Display Mode or you are navigating the FM100 Setup Menus.

During Display Mode

Display Button:

Cycles through sensor readings selected for display

Back Navigation Button:

Cycles between Total readings, Current or Temporary readings, and Hourly/Daily/Monthly Archives

Increase/Down Navigation Button:

Disabled in Display Mode

Enter Button:

Brings up Password prompt to enter Setup Menus

Within FM100 Setup Menus

Display Button:

Switches to Display Mode

Back Navigation Button:

Exit current menu or parameter to previous menu level, or cycles through character positions for text input

Increase/Down Navigation Button:

Cycles to next shown menu or parameter, or increases a blinking value

Enter Button:

Press to enter selected menu or parameter, or accept text input.

• **FM100 Display Mode Menu**

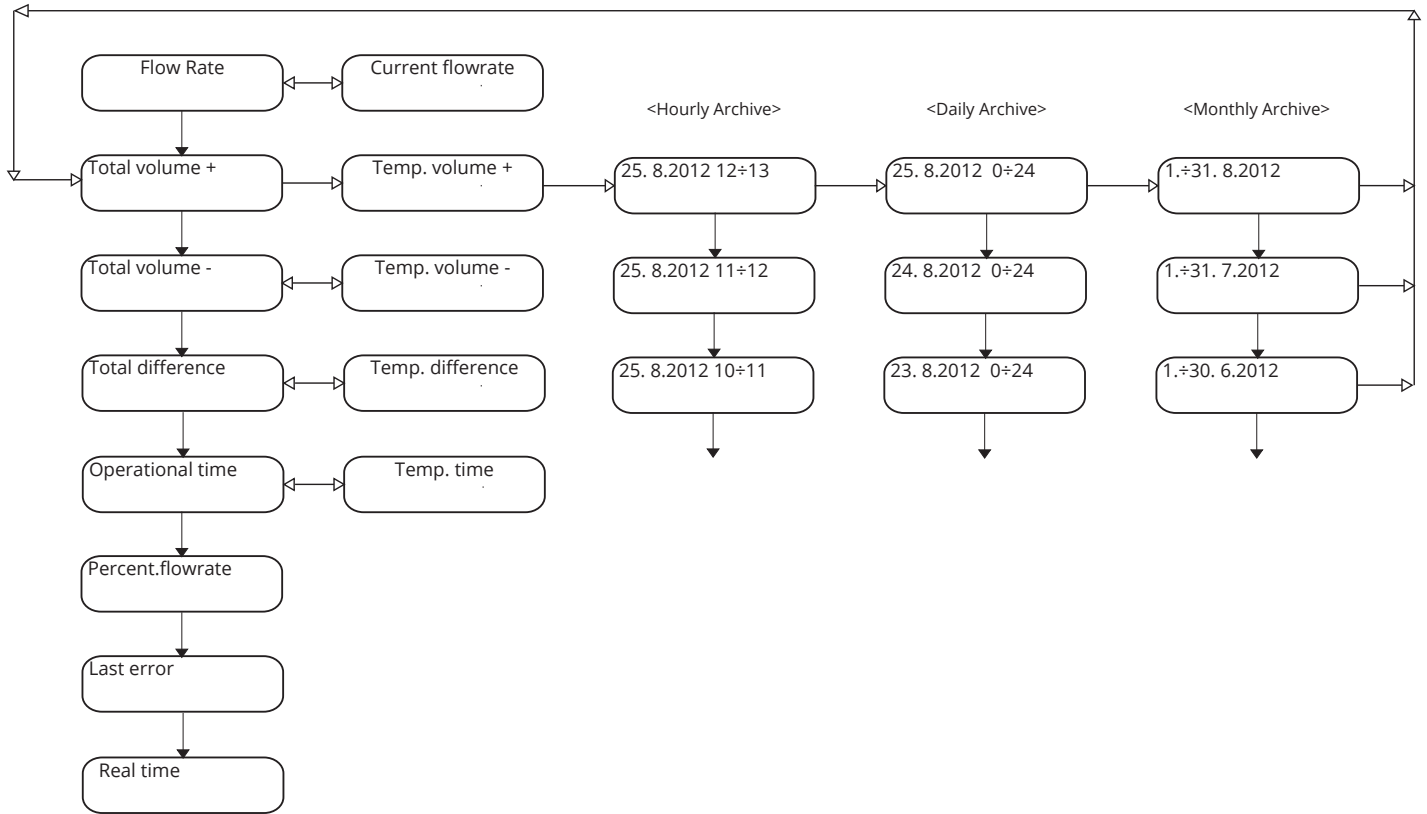

Figure 3.2

• **FM100 Setup Menus**

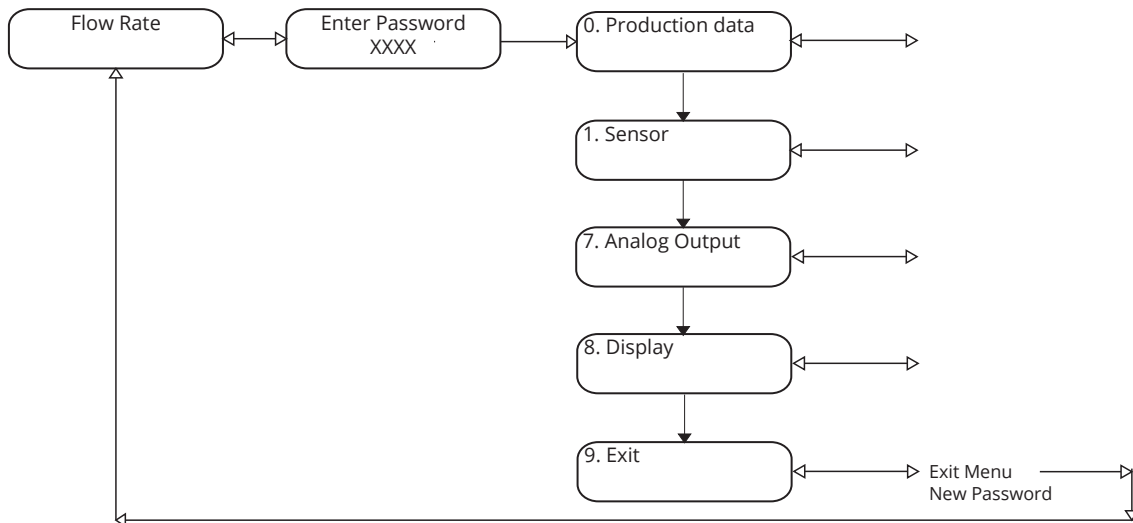

Figure 3.3

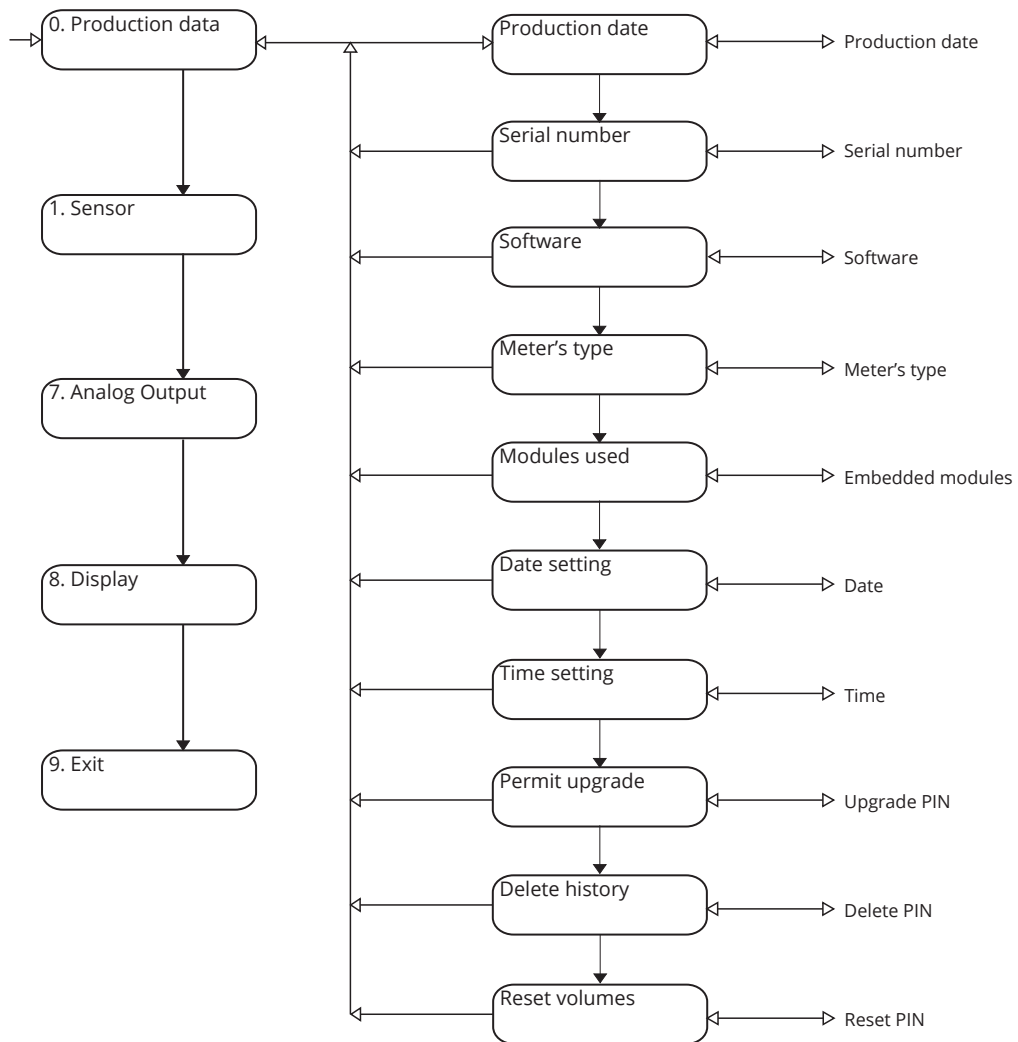

Figure 3.4

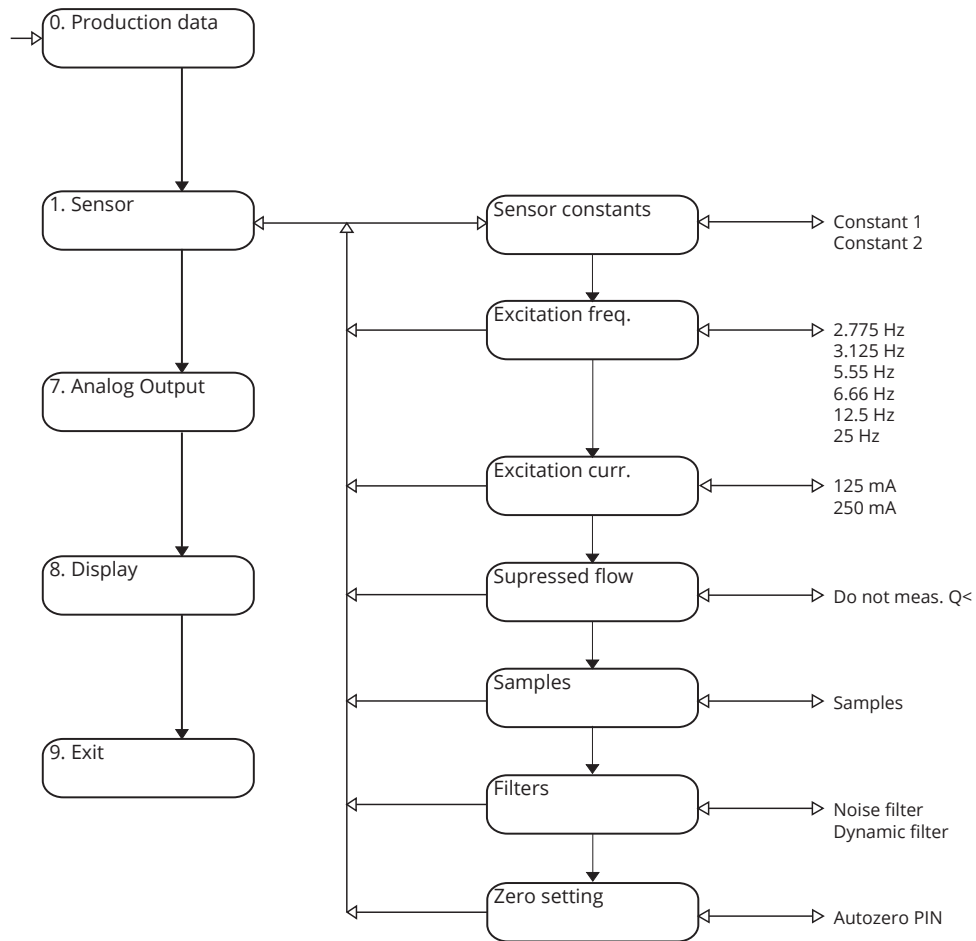

Figure 3.5

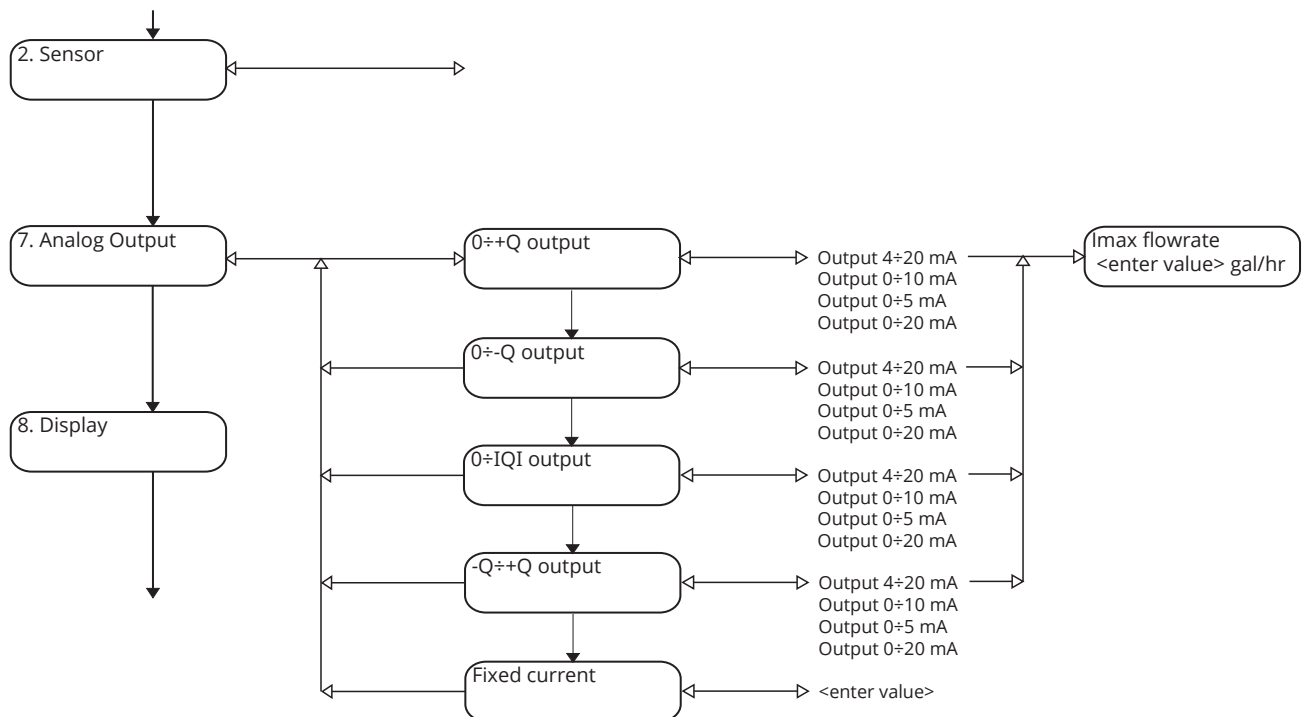

Figure 3.6

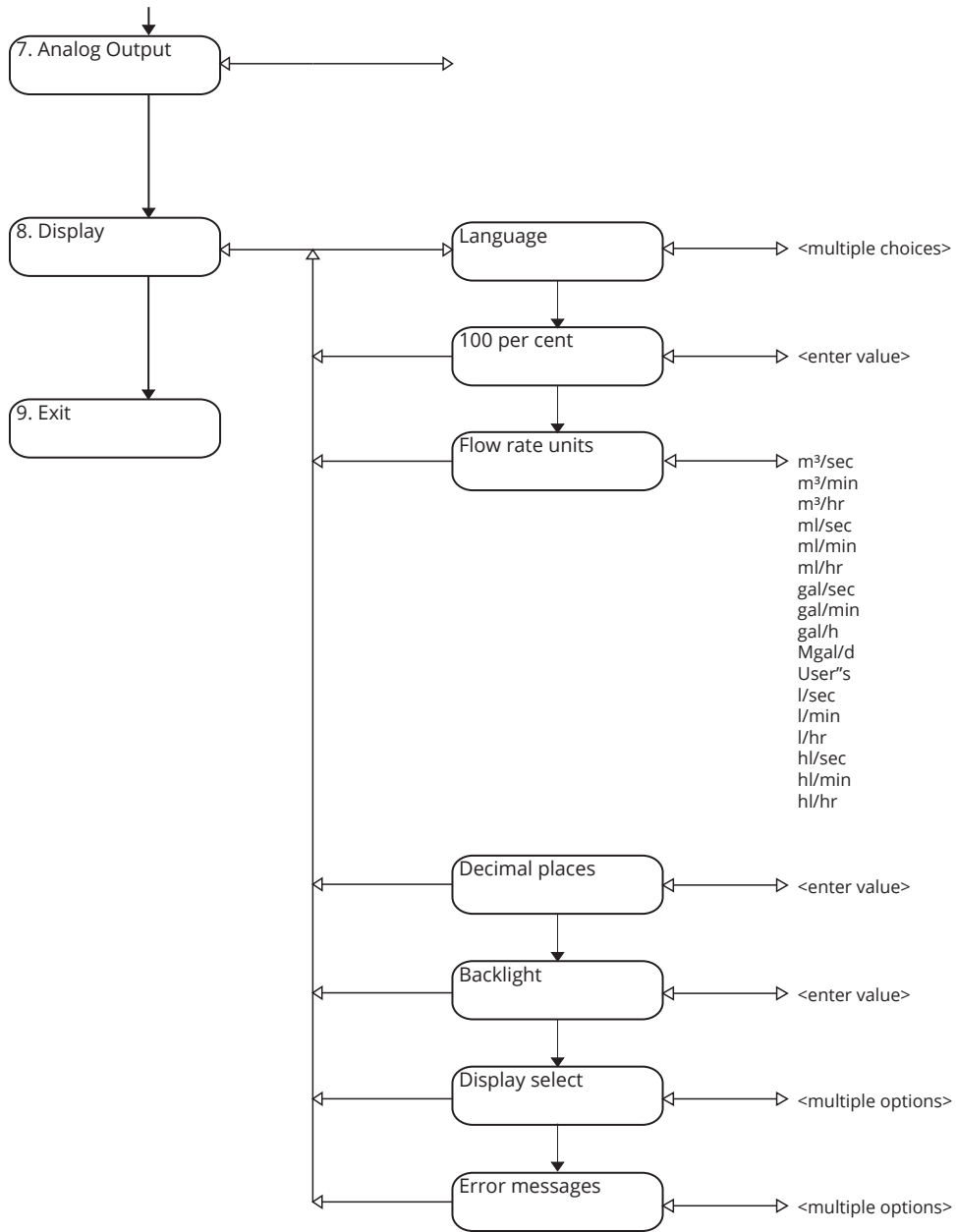



Figure 3.7

- **Enter/Change Password**

The default password for the FM100 Setup Menus is 0000. Correct password entry is required to access the Setup Menus (See Figure 3.3).

To change the password:

1. Use the Increase/Down Button (See Figure 3.1) to navigate through the Setup Menus to 9. Exit (See Figure 3.3).
2. Select 9. Exit using the Enter Button.
3. Use the Increase/Down button to navigate to New Password, and select using the Enter Button.
4. Use the Increase/Down button to increase the value of a blinking character.
5. Use the Back Navigation Button to cycle through the character positions.
6. Use the Enter Button to save the displayed password.

 **NOTE:** Write down your new password, as the correct password must be entered to access the FM100 Setup Menus. Password is NOT required to navigate the Display Mode Menus.

 **IMPORTANT:** You MUST use the Exit Menu to save any changes in the Setup Menus. Cycling back to Display Mode using the Display Button leaves unsaved changes vulnerable to being lost in the event of power outage.

- **Display Mode Menus**

DISPLAY PARAMETER*Flowrate***TEMPORARY/INSTANTANEOUS PARAMETER***Current flowrate*

Flowrate displays an averaged value in the units selected in the Display Setup Menu (Figure 3.7). See *Samples* in the Sensor Menu below for setting the number of samples to be averaged.

Current Flowrate displays an instantaneous, unaveraged value also in the units selected in the Display Setup Menu.

DISPLAY PARAMETER*Total volume +***TEMPORARY/INSTANTANEOUS PARAMETER***Temp. volume +*

Total volume + displays the total volume of liquid that has flowed in the direction of the arrow (Figure 3.8), from the start of measurement.

Temp. volume + displays the total volume of liquid that has flowed in the direction of the arrow during user specified time. See *Temp. time* below.

DISPLAY PARAMETER*Total volume -***TEMPORARY/INSTANTANEOUS PARAMETER***Temp. volume -*

Total volume - displays the total volume of liquid that has flowed against the direction of the arrow (Figure 3.8), from the start of measurement.

Temp. volume - displays the total volume of liquid that has flowed against the direction of the arrow during user specified time. See *Temp. time* below.

DISPLAY PARAMETER*Total difference***TEMPORARY/INSTANTANEOUS PARAMETER***Temp. difference*

Total difference displays the total volume difference between the positive (volume +) and negative (volume -) flows from the start of measurement.

Temp. difference displays the volume difference between the positive (volume +) and negative (volume -) flows during user specified time. See *Temp. time* below.

DISPLAY PARAMETER*Operational time***TEMPORARY/INSTANTANEOUS PARAMETER***Temp. time*

Operational time displays the total time, in hours and minutes from the start of measurement (unit powered on). This is the time used for *Total volume +*, *Total volume -*, and *Total difference*.

Temp. time displays the time elapsed, in hours and minutes, since being set/reset by the user. *Temp. time* is reset by holding the Increase/Down Navigation Button and the Enter Button (See Figure 3.1) at the same time. This will reset *Temp. time* and all three *Temp. volume* parameters.

DISPLAY PARAMETER

Percent.flowrate

Percent.flowrate displays the current flow in a horizontal bar compared to the 100 per cent flow rate set in the Display Setup Menu (See Figure 3.8).

DISPLAY PARAMETER

Last error

Last error displays a shortened version of the last error message. A complete list of error messages is found in the Display Setup Menu (See Figure 3.8).

DISPLAY PARAMETER

Real time

Real time displays the actual time, in 24 hours and minutes, and date (day.month.year), as set in the Production Data Setup Menu (See Figure 3.4).

- **Onboard Archives**

The FM100 automatically archives cumulative flow volumes for three set time intervals: Hourly, Daily, and Monthly. The Hourly archive will maintain up to 192 hours (eight days), the Daily archive up to 192 days (more than half a year), and the Monthly archive up to 12 months.

The screen for each archive is laid out similarly. The top line (See Figure 3.2) shows the time interval. For Hourly and Daily archives, the interval number is listed first, followed by the date and hour interval. For Monthly archives, the time interval is shown as the days of the month (e.g., 1.÷30. or 1.÷30.) followed by the year. The bottom line shows the volume of flow for the stated interval and any elapsed time during that interval that the FM100 was powered off.



NOTE: The Back Navigation Button moves from Daily to Hourly to Monthly archives. The Increase/Down Navigation Button moves back through the selected archive. Pushing the Increase/Down Navigation Button and the Enter Button at the same time returns to the most recent entry in the selected archive.

- **Production Data Setup Menu**

MENU PARAMETER _____

Production date

Production date displays the date the convter box was assembled.

MENU PARAMETER _____

Serial number

Serial number displays the serial number of the converter box.

MENU PARAMETER _____

Software

Software displays the current version of software installed on the converter.

MENU PARAMETER _____

Meter's type

Meter's type displays type number of the flow meter.

MENU PARAMETER _____

Modules used

Modules used lists the modules installed in the converter box.

MENU PARAMETER _____

Date setting

Date setting allows the user to set the current date. The date set here is used for *Real Time* and for the three archives.

MENU PARAMETER _____

Time setting

Time setting allows the user to set the current time. The time set here is used for *Real Time* and for the three archives.

MENU PARAMETER _____

Upgrade enabled

Upgrade enabled allows the user to upload a new firmware version after entering a PIN.

MENU PARAMETER

Delete history

Delete history allows the user to clear the Hourly, Daily, and Monthly archives after entering a PIN.

MENU PARAMETER

Reset volumes

Reset volumes allows the user to reset the display volume totalizers after entering a PIN.

- **Sensor Setup Menu**

MENU PARAMETER

Sensor constants

RANGE

Constant 1
Constant 2

Sensor constants allows the user to set the sensor calibration constants.

MENU PARAMETER

Excitation freq.

RANGE

2.775 Hz
3.125 Hz
5.55 Hz
6.66 Hz
12.5 Hz
25 Hz

Excitation freq. allows the user to choose the frequency of the sensor coils.

MENU PARAMETER

Excitation curr.

RANGE

125 mA
250 mA

Excitation curr. allows the user to choose the current of the sensor coils.

MENU PARAMETER

Supressed flow

RANGE

Do not meas. Q<

Supressed flow allows the user to set a minimum measured flow rate. Measured flow below this level will show as 0 on the display and will not count towards totalizers.

MENU PARAMETER	RANGE
<i>Samples</i>	1 - 256

Samples allows the user to set the number of current flow samples to be averaged for the displayed *Flowrate* (See Figure 3.2). More samples results in a more stable output, but with an increased lag between changes in the measured flow and the displayed output. Fewer samples results in a more volatile output, but less lag time between change in measured flow and change in display. Individual samples count toward totalized volumes.

MENU PARAMETER	RANGE
<i>Filters</i>	Noise filter
	Dynamic filter

Filters allows the user to activate two input signal filters. Noise filter removes lower periodical interference and also dampen the effect of sharp changes in flow, while only causing 0.3 seconds of delay between measurement and output. Dynamic filter significantly reduces the effect of sharp changes in flow. Because the filters operate on the input signal, interference blocked by the filters is not included in cumulative totalizers.

MENU PARAMETER	RANGE
<i>Zero setting</i>	Autozero PIN

Zero setting allows the user to reset the true Zero flowpoint after entering a PIN.

- **Analog Output Setup Menu**

MENU PARAMETER	RANGE	VALUE
<i>0..+Q Output</i>	Output 4÷20 mA	I _{max} flow rate
	Output 0÷10 mA	
	Output 0÷5 mA	
	Output 0÷20 mA	

0..+Q Output maps the current output of the sensor across the range of positive flow detected by the sensor. The user sets the flow rate value to be associated with the max current. 4-20mA is the only Range available.

MENU PARAMETER	RANGE	VALUE
<i>0..-Q Output</i>	Output 4÷20 mA	I _{max} flow rate
	Output 0÷10 mA	
	Output 0÷5 mA	
	Output 0÷20 mA	

0..-Q Output maps the current output of the sensor across the range of negative flow detected by the sensor. The user sets the flow rate value to be associated with the max current. 4-20mA is the only Range available.

MENU PARAMETER	RANGE	VALUE
<i>0.. Q Output</i>	Output 4÷20 mA Output 0÷10 mA Output 0÷5 mA Output 0÷20 mA	I _{max} flow rate

0..|Q| Output maps the current output of the sensor across the range of absolute flow detected by the sensor. The user sets the maximum flow rate value (positive or negative) to be associated with the max current. 4-20mA is the only Range available.

MENU PARAMETER	RANGE	VALUE
<i>-Q..+Q Output</i>	Output 4÷20 mA Output 0÷10 mA Output 0÷5 mA Output 0÷20 mA	I _{max} flow rate

-Q..+Q Output maps the current output of the sensor across the full range of flow, positive and negative, detected by the sensor. The user sets the single flow rate value to be associated with the minimum current (negative flow) and maximum current (positive flow). 4-20mA is the only Range available.

MENU PARAMETER	VALUE
<i>Fixed current</i>	Fixed current [mA]

Fixed current allows the user to set a fixed current output.

- **Display Setup Menu**

MENU PARAMETER	RANGE
<i>Language</i>	<multiple choices>

Language sets the language of the display data and setup menus.

MENU PARAMETER	RANGE
<i>100 per cent</i>	100 per cent

100 per cent sets the 100% flow rate for the *percent.flowrate* bar graph in the Display Mode (See Figure 3.2).

MENU PARAMETER	RANGE	Value 1	Value 2
<i>Flow rate units</i>	m ³ /sec m ³ /min m ³ /hr ml/sec ml/min ml/hr gal/sec gal/min gal/h Mgal/d User's l/sec l/min l/hr hl/sec hl/min hl/hr	Flow rate multipl	Unit's name

Flow rate units sets the volume units used for all displays and totalizers. User's allows the user to define units as a multiple of l/s.

MENU PARAMETER	RANGE
<i>Decimal places</i>	0-4

Decimal places sets the number of displayed decimal places for flow and volume.

MENU PARAMETER	RANGE
<i>Backlight</i>	0 (always off) 1-254 seconds 255 (always on)

Backlight sets the number of seconds the backlight remains on after the last button press.

MENU PARAMETER	RANGE
<i>Display select</i>	Flowrate Total volume+ Total volume- Total difference Operational time Percent.flowrate Last error Real time

Display select allows the user to choose the values displayed in Display Mode (See Figure 3.2).

MENU PARAMETER	RANGE
<i>Error messages</i>	E0 E1 E2 E3 E4 E5 E6 E7 E8 E9 E10 E11 E12 E13

Error messages allows the user to enable or disable each error code. See Chapter 4 Error Messages for explanations of each error message.

- **Exit Menu**

MENU PARAMETER
<i>Exit Menu</i>

Exit Menu save all changes made in Setup Menus and returns the FM100 to Display Mode.

MENU PARAMETER	Value
<i>New Password</i>	4 alpha-numeric characters

New Password sets a new 4-character password for the Setup Menus. See Enter/Change Password.

! IMPORTANT: You MUST use the Exit Menu to save any changes in the Setup Menus. Cycling back to Display Mode using the Display Button leaves unsaved changes vulnerable to being lost in the event of power outage.

Chapter 4: Error Messages

- **Error Codes and Explanations**

ERROR CODE	ERROR TITLE
<i>E0</i>	No Error

E0 indicates no recent error.

ERROR CODE	ERROR TITLE
<i>E1Mx</i>	EEPROM Checksum error

E1 indicates a checksum error (invalid input) in the module indicated (Mx). Check data in indicated module and resave. Menu module numbers are shown in Figure 3.3.

ERROR CODE	ERROR TITLE
<i>E2</i>	Stack overflow
<i>E3</i>	Frequency limit exceeded

E2 and *E3* indicate pulse frequency settings are too low for measured flow rate.

ERROR CODE	ERROR TITLE
<i>E4</i>	Power fail

E4 appears for a short time after a power failure.

ERROR CODE	ERROR TITLE
<i>E5</i>	Old software

E5 indicates that firmware in the converter is too old to work with an installed module. Firmware upgrade is required.

ERROR CODE	ERROR TITLE
<i>E6</i>	Can't use this mode

E6 indicates a module has been installed in the wrong position.

ERROR CODE	ERROR TITLE
<i>E7</i>	Sensor loop disconnected

E7 indicates current is not flowing to the current detecting coils.

ERROR CODE	ERROR TITLE
<i>E8</i>	Empty pipe

E8 indicates full pipe sensor is not submersed.

ERROR CODE	ERROR TITLE
<i>E9</i>	Low medium conductivity

E9 indicates sensing electrodes are not sensing current in fluid.

ERROR CODE	ERROR TITLE
<i>E10</i>	Mbus conflict

E10 indicates networking error.

ERROR CODE	ERROR TITLE
<i>E11</i>	Current output overrange

E11 indicates that flow rate measured is higher than max flow rate set in Analog Output Setup Menu. Increase max current setting.

ERROR CODE	ERROR TITLE
<i>E12</i>	Serial line fail communication error

E12 indicates a network communication error.

ERROR CODE	ERROR TITLE
<i>E13</i>	Sensor signal overrange

E13 indicates the signal from the sensor to the converter is beyond the converter's range. Check sensor and cables for short circuit.

Chapter 5: Maintenance

- **General Care**

Your FM100 flowmeter is very low maintenance and will need little care as long as it was installed correctly (See Installation Requirements and Recommendations, pages 5-7). However, in general, you should:

- Avoid applications for which the sensor was not designed, such as extreme temperatures, contact with incompatible corrosive chemicals, or other damaging environments.
- Ensure that the sensor chamber is fully flooded whenever the sensor is powered on.

- **Trouble Shooting**

Should you have problems with your FM100, here are some troubleshooting steps.

- Check the *Last Error* display (See Figure 3.2) for recent error. See Chapter 4 Error Messages for error codes and explanations.
- Check that all wiring is connected correctly and securely.
- Check that sensor is grounded correctly and completely (See Grounding Instructions, page 8).

- **Repair and Returns**

Should your flowmeter require service, please contact the factory via phone, email, or online chat. We will issue you a Return Material Authorization (RMA) number with instructions.

- Phone: 888-525-7300
- Email: sales@apgsensors.com
- Online chat at www.apgsensors.com

Please have your FM100's part number and serial number available. See Warranty and Warranty Restrictions for more information.



Automation Products Group, Inc.

Tel: 1/888/525-7300 • Fax: 1/435/753-7490 • www.apgsensors.com • sales@apgsensors.com