

Thank You

Thanks for purchasing an LPD Loop Powered Display from us! We appreciate your business and your trust. Please take a moment to familiarize yourself with the product and this manual before installation. If you have any questions, at any time, don't hesitate to call us at 888-525-7300.

NOTE: Scan the QR code to the right to see the full user manual on your tablet or smartphone. Or visit <https://www.apgsensors.com/support> to find it on our website.



Table of Contents

1. Description	6. Pinouts and Sensor Wiring Diagrams
2. How To Read Your Label	7. Menu Flow Chart
3. Warranty	8. General Care
4. Mounting Instructions & Electrical Installation	9. Repair Information
5. Dimensions	10. Removal Instructions

1 Description

The LPD provides a local display that can be wired downstream of any 4-20 mA sensor. It features a large 5-digit display, housing options rated to IP67, and user selectable units of measure. Setup is easy using the 3 buttons on the display. The LPD can also be programmed using RS-845/Modbus.

2 How To Read Your Label

Each label comes with a full model number, a part number, and a serial number. The model number for the LPD will look something like this:

▲ SAMPLE: LPD-00201M2C150

The model number tells you exactly what you have. You can also call us with the model, part, or the serial number and we can help you.

3 Warranty

This product is covered by APG's warranty to be free from defects in material and workmanship under normal use and service of the product for 24 months. For a full explanation of our Warranty, please visit <https://www.apgsensors.com/about-us/terms-conditions>. Contact Technical Support to receive a Return Material Authorization before shipping your product back.

Scan the QR code below to read the full explanation of our Warranty on your tablet or smartphone.



4 Mounting Instructions & Electrical Installation

How you mount your LPD will depend on the enclosure and mounting configuration of your LPD. If you have a question or need help, please contact us.

Here are a few tips:

- If you have a rubber boot, slide cord through boot, push the rest on.
- If your mounting bracket has a front and back, screw the back on first and then the front.

For normal operation, connect the provided cable to your control system:

- For LPDs with connectors, make the connection.
- For LPDs with flying leads, connect the leads to your terminal strip.

For programming via RST-6001 and APGModbus software:

- Connect RS-485 A(+) from the LPD to RS-485 A on the RST-6001.
- Connect RS-485 B(-) from the LPD to RS-485 B on the RST-6001.
- Connect USB on the RST-6001 to computer.
- Initiate APG Modbus software on the computer.
- Disconnect LPD from RST-6001 when done programming.

NOTE: APG Modbus Software can be downloaded from www.apgsensors.com/support.

IMPORTANT: DO NOT leave LPD connected to RST-6001 after programming. Lack of shared grounds between 4-20 circuitry and RST-6001 can damage device LPD and/or RST-6001.

LPD - Loop Powered Display Installation Guide



Automation Products Group, Inc.
1025 W 1700 N Logan, UT 84321
www.apgsensors.com | phone: 888-525-7300 | email: sales@apgsensors.com

Part # 122950-0028
Doc #9004638 Rev A

5 Dimensions

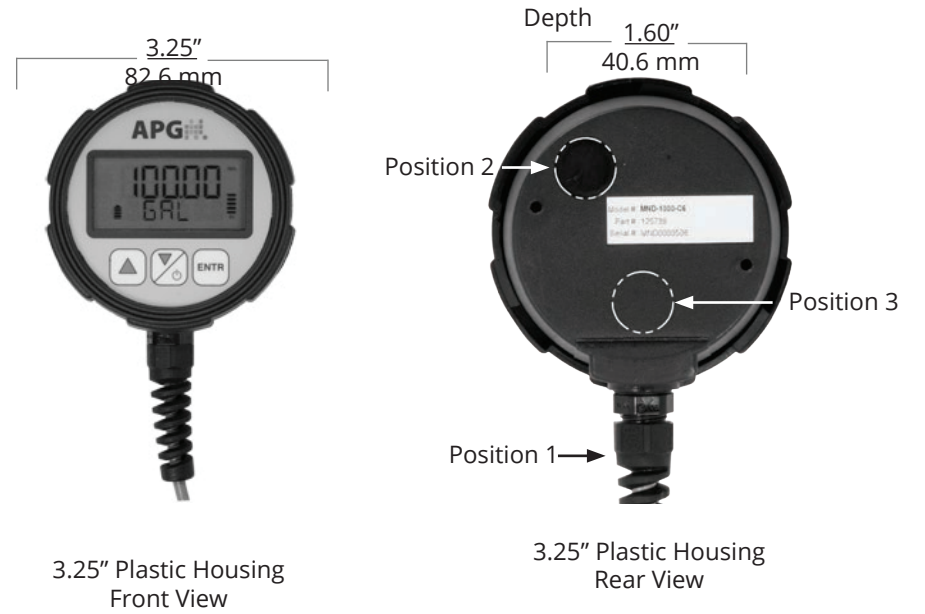

3.25" Plastic Housing
Front View

3.25" Plastic Housing
Rear View

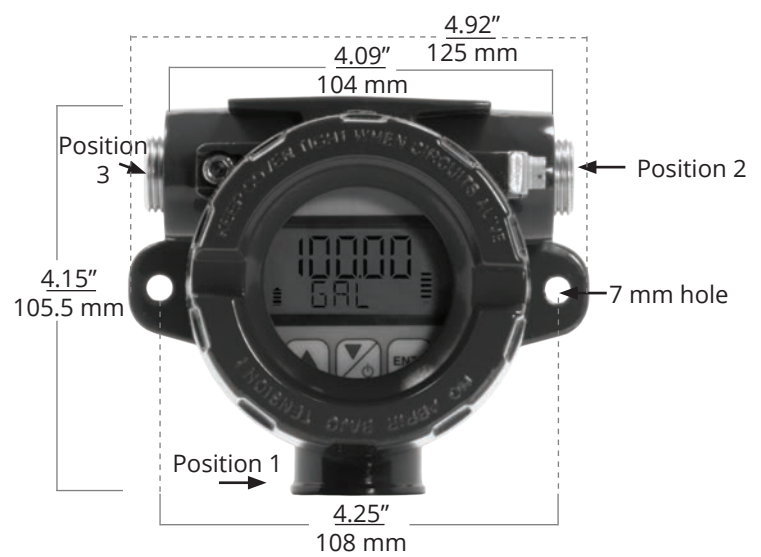

3" Aluminum Housing

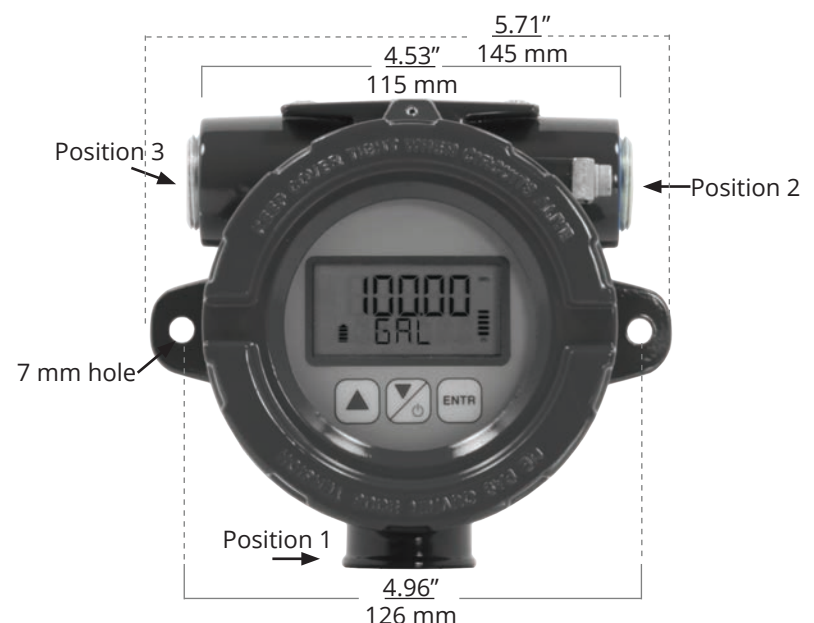

4" Aluminum Housing

6 Pinouts and Sensor Wiring Diagrams

4 Conductor Cable (22 AWG, 2 Twisted Pair)

	4-20 mA Only	RS-485
4-20 mA IN	Red	Red
4-20 mA OUT	Black	Black
RS-485 A+		White
RS-485 B-		Green

*No connection for White/Green on LPD without RS-485 Programming

4-pin Male M12

	4-20 mA Only	RS-485
1 Brown	4-20 mA IN	4-20 mA IN
2 White	*	RS-485 A+
3 Blue	4-20 mA OUT	4-20 mA Out
4 Black	*	RS-485 B-

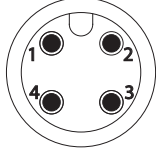

*No connection for LPD without RS-485 Programming

4-20 mA Circuit without Programming

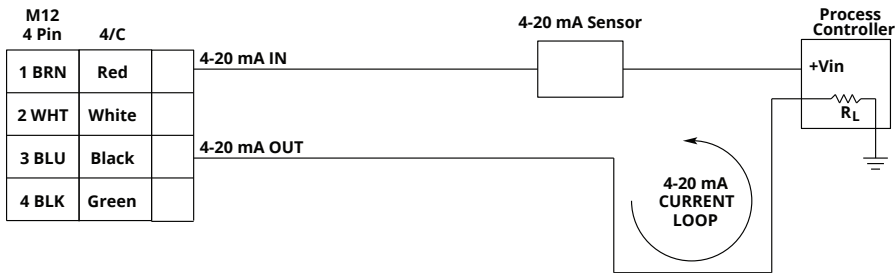

4-20 mA Circuit with LPD Modbus Programming

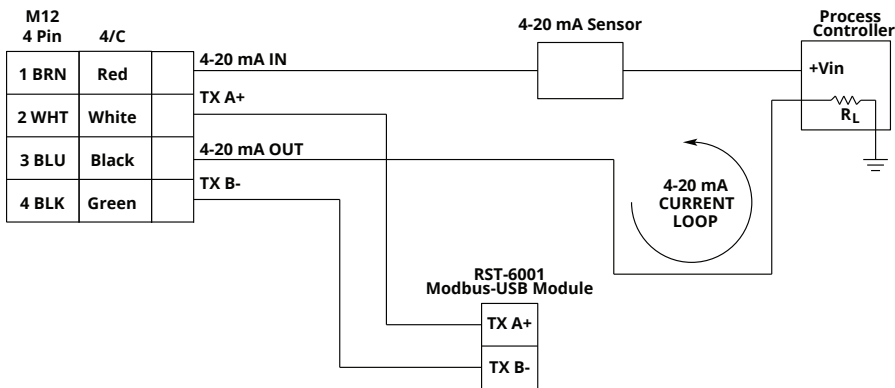

ⓘ IMPORTANT: APG Modbus equipment uses reversed TX+/TX- pins. When making connections with other APG Modbus equipment, ensure continuity of A to A and B to B pins. When connecting to the LPD from other Modbus systems, ensure continuity of TX+ to TX+ and TX- to TX- pins.

7 Menu Flow Chart

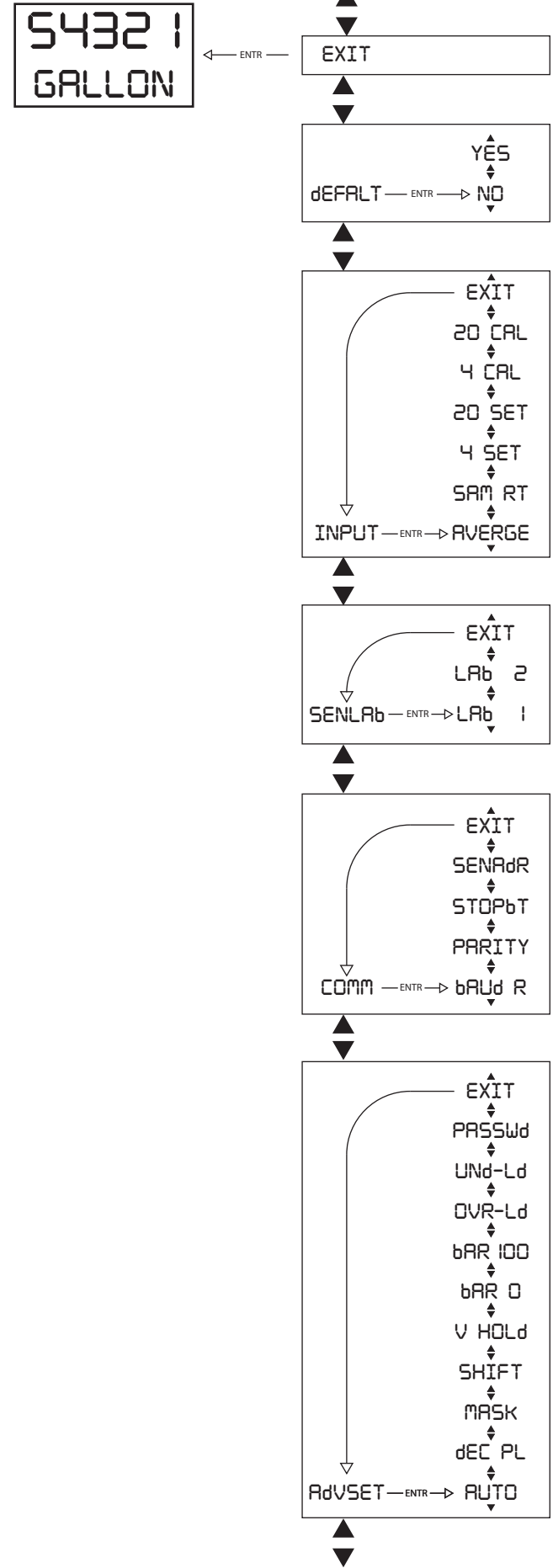

8 General Care

Your LPD is very low maintenance and will need little care as long as it was installed correctly. However, in general, you should periodically inspect your LPD to ensure the display face and body are free of any buildup that might impede the functionality of the display. If sediment or other foreign matter penetrates the display face or body, display errors might occur.

Always disconnect your LPD from the Modbus Network after programming.

If you need to remove your LPD, be sure to store it in a dry place at a temperature between -40° and 160° F.

9 Repair Information

If your LPD needs repair, contact us via email or phone. We will issue you an RMA number with instructions.

- Phone: 888-525-7300
- Email: sales@apgsensors.com
- Online chat at www.apgsensors.com

10 Removal Instructions

- Ensure power to the LPD is off.
- Disconnect wires or connector on cable to LPD.
- Remove the controller and store it in a dry place, at a temperature between -40° F and 160° F.